

# HEZZO<sup>®</sup>

more riding pleasure

scooter E-bike E moto



## User's Manuel

2023-2025

Please read the  
instruction before use



## ABOUT HEZZO

HEZZO is an international brand in UK, EU and US in order to provide high-end qualified ebikes and scooters to the worldwide buyers. HEZZO is designed and produced based on the philosophy of advanced technologies and innovations. We listen carefully to our consumers and investigate each details of improvement .The brand owner, Speedy Flying Group are the direct manufacturer of electric bicycle and scooter since 2006".we accept OEM &ODM orders too!

## GREEN INITIATIVE

HEZZO scooters are created based on the idea of environmental protection, we wish to protect our planet by changing the method of trip mode.

## MORE RIDING PLEASURE

High-capacity motor coming with original LG/SAMSUNG Lithium battery ,  
Comfortable & elegant designs with full suspension enable to complete a wonderful tour.

## FAST DELIVERY

HEZZO maintain a stable stock in UK、EU and US (under planning) warehouse,the individual order will be dispatched within 72 hours during the working days  
For bulk or OEM orders , please consult us by email.

## HEZZO SERVICE

HEZZO provide 1-2 years' warranty for frames, motors ,batteries for performance failure  
The HEZZO team are ready to react to your request within 24 hours .the HEZZO overseas distribution & service networks in UK、EU、AUSTRALIA、CANADA and US are for display showroom and after-sale services.

---

# INDEX

|   |                  |
|---|------------------|
| 1.The Device& Accessories                   | Page 1           |
| 2.Functions                                 | Page 1           |
| 3.Assembling                                | Page 2           |
| 4.Charging scooter                          | Page 3           |
| 5.Learning driving                          | Page3            |
| 6.Safety Instructions                       | Page 4 to Page 6 |
| 7.Folding & Transportation                  | Page 6           |
| 8.Care and Storage                          | Page 7           |
| 9.Parameters                                | Page 8           |
| 10.Presence of toxic and harmful substances | Page 9           |
| 11.Warranty                                 | Page 10          |

# 1. The Device & Accessories

## Vehicle

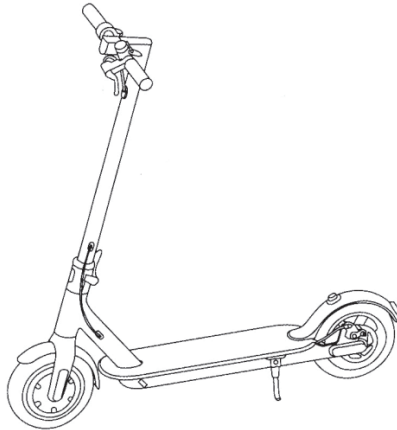

## Accessories



Fitting for wheels swap



Charging Adapter

## 2. Functions

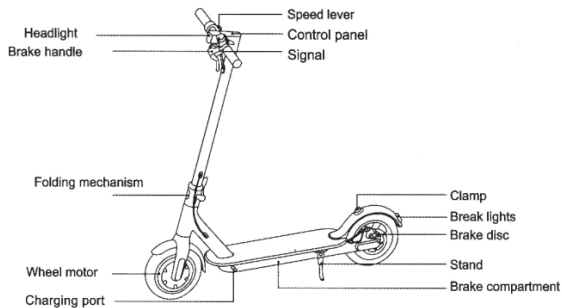

### Mode Indicators



The control panel has 5 LEDs, indicating a level of charge. During consumption of a battery, status indicators are lit, then flashes and final off one by another. If all 5 LEDs are lit, a battery level is 100%-86%; if 4 LEDs are lit, and one is blinking, charging level-85%-71%; so all charge level lights begin to flicker, and then does not light.

Lowest charge level indicator may be white or green. When the vehicle is in normal operation, LED glows white; if the scooter running in power saving mode, indicator lit green. ( In power saving mode: the maximum speed is 18km/h, speed level is adjusted more smoothly, that is more suitable for beginners.)

1. Long press (3 seconds), turn on/off function.
2. After starting the machine, press once to turn the headlight on/off.
3. After starting the machine, press the button for 2 consecutive times and switch to 1/2/3 gear.
4. After starting the machine, press the button for 4 consecutive times to switch to zero start/non-zero start.
5. After starting up, press 5 times in succession to switch the color of the speed code table.
6. After starting the machine, press the button for 6 times in succession, and then switch to km/mil



### 3. Assembling the device

1), fix the steering rod and open the parking bridge

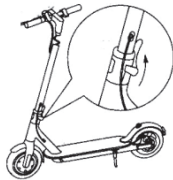

Using hex wrench in the packing box to tighten the screws on handle bar

2), Set handle bars vertical;

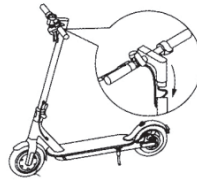

4. Testing the power switch after finish assembling

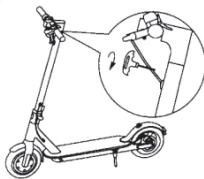

#### Power Button

Press power button to turn on the vehicle. Press and hold a button for 2 seconds to turn on the device. When switched on : press power button to turn on/off a flashlight ; press a power button twice to normal mode and power saving mode.

## 4.Charging scooter

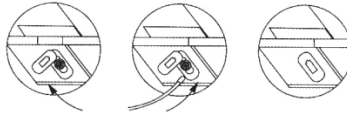
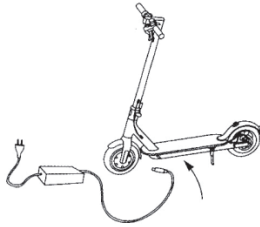

Open the cover connect the charger close the cover

## 5.Learning driving

Please wear helmet and knee pads when practice

1 .Power on and check the battery led light

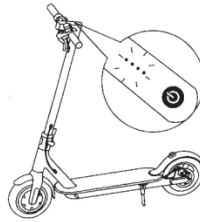
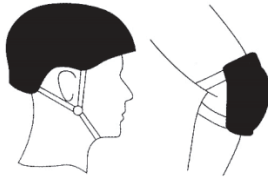

2.,Stand on pedal with one leg,  
hit the ground with the other leg

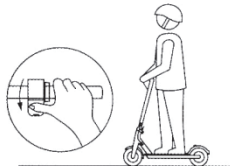

3.,Step on the other leg when the scooter is moving, then press the accelerate button (only accelerate when the scooter speed is beyond 5km/h)

4.loose the accelerate button when slow down. Energy recovery systems will open itself to slow down. Press the left disc brake tightly if want to brake urgently.

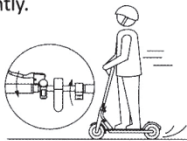

5.lean your body left slightly to turn left,  
lean your body right slightly to turn right.  
And turn the handlebar slowly

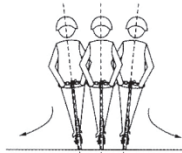

## 6 Safety Instructions

It is not recommended driving on the rain



Entering into any room, elevator, etc.

Be careful not be injured by a door frame.

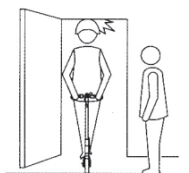

It is recommend to slightly bend knees to better adjust to a rough road.If you are travelling on a rough road,stick to low speed (5-10km/h)



Please not add speed when descending a hill



While walking with a scooter, do not press a speed knob

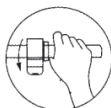

When driving it is recommended to go around various obstacles on a road



Please do not hang backpacks and other heavy objects on handle bars ground



When driving is forbidden to place one foot on the running board or on the ground



# Preventing dangerous driving

It is forbidden to leave a scooter on a scooter wheel at high roadway for motor vehicles or ride in at a high speed

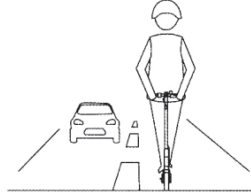

It is forbidden to sharply turn a residential area with a large flow of passers-by

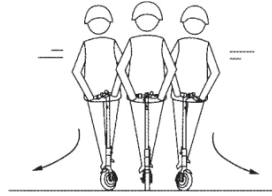

It is forbidden to drive through puddles, to which exceeds depth of 2cm.



Never rider a scooter more than or one person, hold a child in your arms.

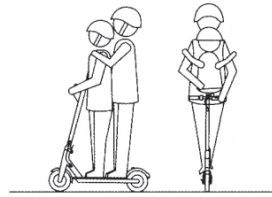

Do not tread the back of the fender

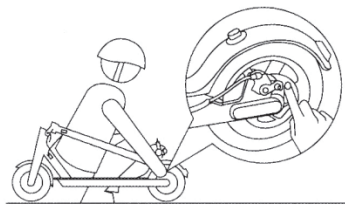

Do not touch the disc brake



Do not driving leaving your hands

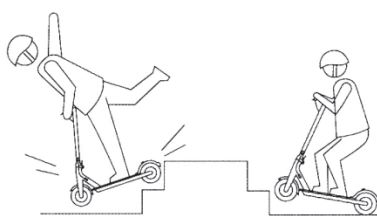

Do not riding electric scooter up, down steps or jump over obstacles



## Safety Recommendations

- 1) Electric scooter - it is only a device for entertainment, not vehicle. But once you driving to public area, the electric scooter brings certain risks for your safety. For the sake of your safety and others safety, you must strictly follow the instructions, outlined in this driving manual.
- 2) You should understand that is you ride a scooter in a public place, you must comply with all recommendations for safety. Also do not forget that there is a possibility of collision, due to violation of pedestrians or vehicles traffic rules, there is also a risk of injury, due to improper operation of the unit. As in other types of vehicles, the higher a speed of electric scooter, the greater a braking distance. On some smooth road emergency braking may cause skidding of scooter, loss of balance and even fall. Therefore, during moving of scooter you need to be vigilant, to adhere to an appropriate speed, keep a safe distance from pedestrians and / or with other vehicles. Riding on unfamiliar terrain, keep vigilance and appropriate speed.
- 3) While riding scooter, respect rights of pedestrians. Do not scare them, especially children. Reduce speed, passing by them. If you are moving in the same direction with pedestrians, try to stick to the left side as much as possible (for right-hand traffic countries). If you are moving in the opposite direction, stick to the right and slow down.
- 4) Please strictly following your country road rules to driving, and also strictly abide by rules, set out in the instructions and safety recommendations. Violation of the above rules may result financial expenses, personal injury, occurrence of traffic accidents, legal disputes, conflict and other unpleasant situations. Our company does not bear any direct or joint and several liability.
- 5) To avoid personal injury, do not loan electric scooter to others whom do not know how to drive. Please spend a training before you transfer your scooter to friends, as well as teach he(her) must be wear the proper safety gear.
- 6) Please do inspect scooter carefully before each use. If you find shattered parts, battery life has decreased obviously, tires leak air or there are signs of excessive wear, uncharacteristic sounds when turning or other abnormal symptoms, please discontinue use of the scooter immediately, don't drive it reluctantly.

## 7. Fold and Transportation

### Fold

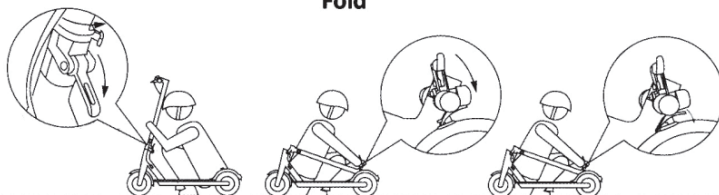

Make sure scooter be off, hold the front pole, loosen a lock lever and lower a steering rack. Adding a steering rack in a horizontal position and secure it by inserting a hook through a special ring, which is located on the rear wheel mudguard. To Assemble the scooter, disconnect a steering rack lock from a hook of a mudguard, and then lift it into a vertical position and lock a lever.

### Transportation

You can transfer folded scooter with one hand



## 8.Care and Storage

### Clean and store Electric Scooter

If you find any stains on electric scooter housing, use a soft,damp cloth to wipe the vehicle;You can use toothpaste and a toothbrush to clean the scooter from stains, and then wipe it clean with a damp cloth. If you find scratched on parts , made of plastic, use sandpaper or other grinding materials for their polishing .

Warning : Do not use alcohol, petrol,kerosene or other corrosive solutions , volatile chemical solvents to clean the vehicle. Otherwise,it will cause serious damage to the scooter body and can disrupt a structure of internal elements. Do not wash electric scooter under a strong pressure of the water, make sure the scooter in the off status. In addition, after charging of the vehicle, it is necessary to insert a plug back to a charging connector,otherwise you may get an electric shock , or may have serious water damage cause from water falling into this hole ,may have serious water damage.

If you do not use the scooter ,store it in a dry ,cool place and do not leave the unit for a long time on the street.Leaving the device under the sun/in extremely high temperature/over-low temperature can cause rapid aging of an outer body and wheels of Electric Scooter or reduce battery life.

### Maintenance of Electric Scooter battery

- 1)Do not use batteries from other brands in order to avoid a dangerous situation;
- 2)Do not open or disassemble the battery to prevent electric shock.Avoid contact with metal objects to prevent an occurrence of a short circuit. Otherwise,the battery may have malfunction or can injure the user;
- 3)It is recommended to use an AC adapter,that comes in original configuration of

the device,to prevent an occurrence of an accident or fire of the vehicle;

4)Improper disposal of used batteries and accumulators is the cause of severe environmental pollution.Please,dispose of batteries in accordance with local laws.Please do not dispose of batteries together with food waste.Protecting the environment together!

5)After each use of the device,charge the battery to prolong its service life.

Do not store the scooter battery in rooms with temperatures,that exceed 50°C or -20°C(for example,do not leave the battery of Electric Scooter and other batteries in cars in summer time on the hot sun),do not leave the battery near fire.As a result of these actions may deteriorate the battery,overheating and can even cause inflammation.

If within 30 days the scooter is not used,charge the battery and keep the device in a cool,dry place.Every 60 days you need to charge the battery,otherwise there is the likelihood of its failure,which is not subject to warranty services.

Avoid a full discharge of the device,it will to extend battery life.When using the device at normal room temperature,the battery will be able to ride much greater distance and its performance will be better;but if you use the scooter at temperatures below 0C,vehicle performance and permeability decrease.

At -20C a traveled distance is less,than the scooter in the normal conditions of half or even less.If a temperature rises,a traveled distance by the vehicle will also increase. You can check remaining distance in the Application.

Note:A fully charge scooter runs about 120-180 days of standby time.The battery has a smart chip,that stores information about its charging-discharging.If you are not charging the battery for a long time,it can cause serious damage,for which it is impossible to charge the device again.This kind of damage is not included in free warranty service.(Caution:Do not disassemble the device by unauthorized people,as there is a risk of electric shock or serious injury as result of a short circuit.

## Adjusting a brake disc

If a brake is very tight:using M5 hex wrench and scroll counterclockwise screws of brake disc tensioner pulley,slightly shorten a length of a tail brake cable,then tighten a tensioner pulley.If you think that brake is very free,loosen a tension pulley,pull a brake cable to slightly increase a length of its tail.Tighten a tension pulley.

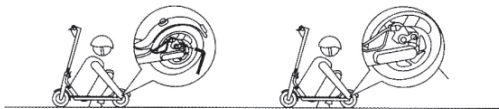

## Adjusting a handle bars

Staggering of steering rack: using a M5 hex wrench,tighten two screws near the folding mechanism.

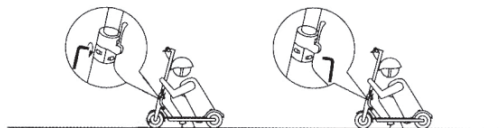

## Using a connecting pipe to pump wheels

If a rear wheel of Electric Scooter deflated,connect a connecting pipe to a wheel nipple to pump it .First,remove the a cap of pin,then tighten a fitting,and then you start to pump a wheel.



## 9.Parameters

|                    |   |   |      |
|--------------------|---|---|------|
| Dimensions         | Length x Width x Height[1] (cm)           | 106 x 42 x 48   |      |
|                    | Folded:Length x Width x Height(cm)        | 106 x 42 x 48   |      |
| weight             | Gross weight                              | 15kg  | 16kg |
| Conditions         | Max load                                  | 120kg   |      |
|                    | Age                                       | 16-50   |      |
|                    | Height(cm)                                | 120-200   |      |
| Main Parameters    | Max speed(km/h)                           | 20  |      |
|                    | Possibility in average condition [2] (km) |   |      |
|                    | Maximum slope(%)                          | 11  | 14   |
|                    | Suitable area                             | Solid road surface,smooth clay surface to overtime,obstacles high less than 1cm,a depth of pools no more than 2cm |      |
|                    | Operating temperature range(°C)           | -10-40  |      |
|                    | Temperature of storage(°C)                | -20-45  |      |
| Battery Parameters | Waterproof level                          | IP54  |      |
|                    | Rated voltages(VDC)                       | 36B   |      |
|                    | Max voltage of charging(VDC)              | 42B   |      |

|                          |                                 |   |        |
|--------------------------|---------------------------------|---|--------|
|                          | Smart battery management system | Stress,insufficent voltage,short circuit,auto sleep/wake up,overheating protection,control of battery using |        |
| Motor Parameters         | Rated power(W)                  | 250   | 350    |
|                          | Max power(w)                    | 400   | 600    |
| power adaptor parameters | Rated power(W)                  | 42  |        |
|                          | Rated input voltage(VAC)        | 100-240B  |        |
|                          | Rated output voltage(VDC)       | 42V   |        |
|                          | Rated current(A)                | 1   |        |
|                          |                                 |   |        |
|                          | Charging time(h)                | Est . 4   | Est. 6 |

## 10.Presence of toxic and harmful substances

| Name            | Toxic and harmful substances elements |    |    |      |     |      |
|-----------------|---------------------------------------|----|----|------|-----|------|
|                 | Pb                                    | Hg | Cd | Cr6+ | PBB | PBDE |
| Power adaptor   | X                                     | O  | O  | O    | O   | O    |
| Battery         | X                                     | O  | O  | O    |     | O    |
| Connecting pipe | X                                     | O  | O  | O    |     | O    |
| Charging port   | X                                     | O  | O  | O    |     | O    |
| Indicators      | X                                     | O  | O  | X    | X   | X    |
| Circuit board   | X                                     | O  | O  | X    | X   | X    |
| Motor           | X                                     | O  | O  | X    | O   | O    |
| Housing         | X                                     | O  | O  | O    | O   | O    |

Date provided in accordance with provisions of SJ/T 11364.

O:toxic and harmful substances in all components of the device are contained in an amount below the limit value,according to standard GB/T 26572-2011.

X:presence of toxic and hazardous substances at least one of components of the device in an amount,that exceeds the threshold,according to GB/T 26572-2011

## 11. Warranty

Warranty service is carried out in accordance with the law on 《consumer rights》 and the 《Law on the quality of products.》 The warranty service includes:

Recommendation: use the packaging for safe transport of the device. We recommend keeping the original packaging within 15 days after receipt of goods.

### I. Warranty terms

| Name                                    | Information on warranty maintenance  | Term        |
|---|--|-------------|
| Main Unit                               | Frame, hub motor, controller, steering<br>Wheel, handle bar, control panel, rear hub,<br>brakes, disc brakes<br>(folding) system, fork, front fork<br>governance system bus<br>control.brake cable                     | 1 year      |
| Accessories                             | Battery, power supply, brake level,<br>switching gears   | 6<br>months |
| Exterior parts, that<br>easily wear out | Anti-collision strip, headlights, instrument<br>cover, handle sets, tires, inner tubes, bell,<br>fender, taillights, decorative cover,<br>stand, battery compartment cover, foot pad,<br>charging port, rubber stopper | 3<br>months |

Caution:

Hex wrench, connecting pipe and other consumable component parts have no warranty.

### II. Non - warranty regulations

1. Authorized maintenance, misuse, collision, negligence, abuse, intake, accident. Improper use of non-product accessories, or tear up the modified label, anti-counterfeit mark.
2. The warranty period has expired;
3. Damage, caused by force majeure;
4. Failures, which do not correspond to the 《List of faults》 of EcoRider service center;
5. A failure of the device or its components from the 《Fault list》, which arose in connection with the human factor, and which interfere with normal operation.
6. Failures, that have arisen in connection with the human factors (including, but not limited to, excessive wetting device, puncture, drop, scratch and damage an outer casing, which have arisen as a result of normal use of goods)
7. If this product is used for commercial purposes, all warranty conditions are not maintained.

### III. List of faults

| Name of fault    |  |
|------------------|--|
| Electric Scooter | Incorrect motor operation                          |
|                  | Problems with operation of the controller          |
|                  | Problems with charger                              |
|                  | Problems with battery                              |
|                  | In use, the occurrence of cracks, deformation, etc |

# HEZZO

|                                  |  |             |                |     |  |
|----------------------------------|--|-------------|----------------|-----|--|
| User name                        |  | Sex         |                | Age |  |
| Address                          |  |             |                |     |  |
| Telephone                        |  |             |                |     |  |
| Purchasing address               |  |             |                |     |  |
| Retail price                     |  | Odd Numbers |                |     |  |
| Commodity name and specification |  |             | Model No.      |     |  |
| Dealer Signature                 |  |             | User Signature |     |  |

## NOT COVERED BY WARRANTY

1. The warranty period has passed.
2. Commercial lease.
3. The gifts presented are not covered by the warranty.
4. Unauthorized modification or disassembly, replacement of accessories causes damage.
5. Warranty will not be provided if the user uses improperly, or is damaged, damaged, watered, or overloaded, causing damage to the accessories.
6. As the factory batch or upgraded parts of electric vehicles will be changed, our company will not notify you separately. Our company guarantees that the changed parts will only improve the quality, please be aware.

| Project               | Accessories | warranty period | Warranty conditions                          |
|-----------------------|-------------|-----------------|--|
| Electrical appliances | Motor       | 12 months       | Performance failure                          |
|                       | Charger     | 6 months        | Performance failure                          |
|                       | Controller  | 6 months        | Performance failure                          |
|                       | Battery     | 6 months        | The battery is less than 60% of the original |
| Basic parts           | Turn handle | 6 months        | Performance failure                          |
|                       | Frame       | 24 months       | There are natural opening and desoldering    |
|                       | Tire        | 3 months        | Natural cracking                             |





# HEZZO<sup>®</sup>

more riding pleasure

scooter E-bike

